

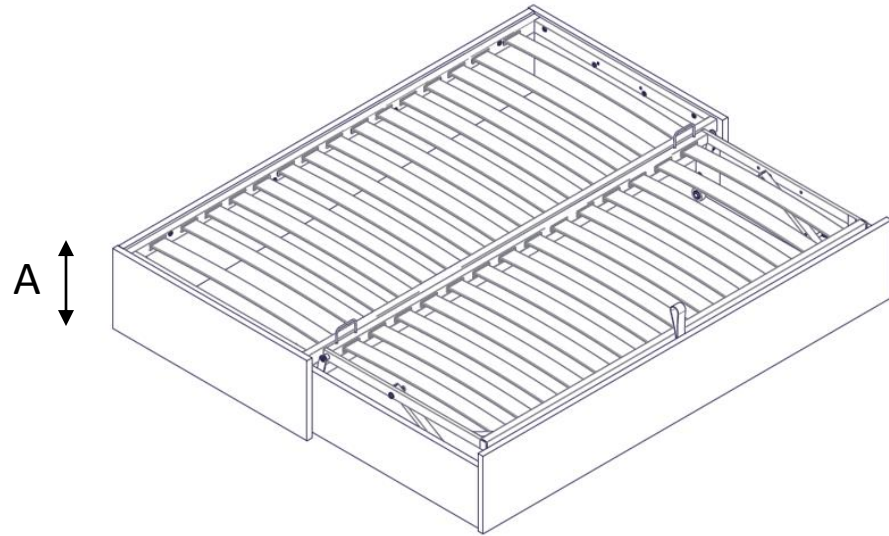

New BOXY H20



MODIFICHE / UPGRADES – ALTEZZA & MISURA MATERASSO / HEIGHT & MATTRESS SIZE



BOXY

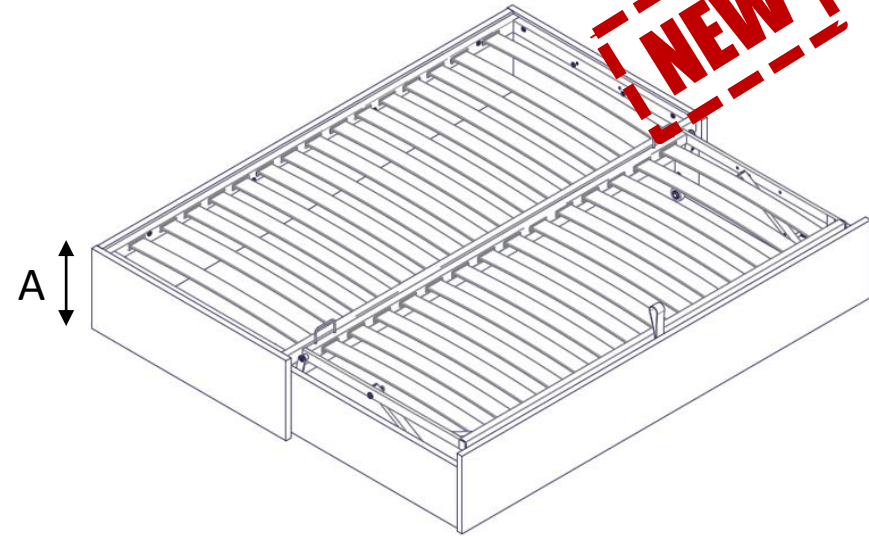

BOXY H20

Modello / Model	Altezza materasso / Mattress height	Altezza letto / Bed height (A)
<i>BOXY</i>	15 CM	33 CM
BOXY H20	20 CM	42 CM

MODIFICHE / UPGRADES – COLORE / COLOUR



BOXY



BOXY H20



*Da GRIGIO ALLUMINIO a GRIGIO ANTRACITE /
From ALUMINIUM GREY to ANTHRACITE*

MODIFICHE / UPGRADES – NUOVO BREVETTO MANIGLIA / NEW PATENTED HANDLE

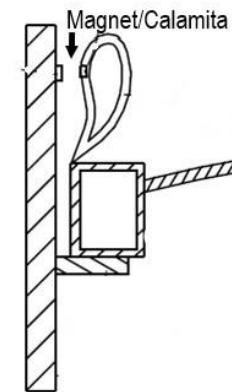

La nuova maniglia è tenuta in posizione da una calamita per una facile estrazione / The handle is kept in position where it is easily to be grabbed thanks to a magnet

BOXY

BOXY H20

RIGHT HEAD / FOOTBOARD PANEL

TESTIERA / PEDIERA DESTRA

RIF.	DESCR.	QT
A	$\varnothing 10 \nabla 15 \sphericalangle \varnothing 14 \times 90^\circ$ FOR BUSHINGS M8x15 $\varnothing 10 \nabla 15 \sphericalangle \varnothing 14 \times 90^\circ$ PER BUSSOLE M8x15	6

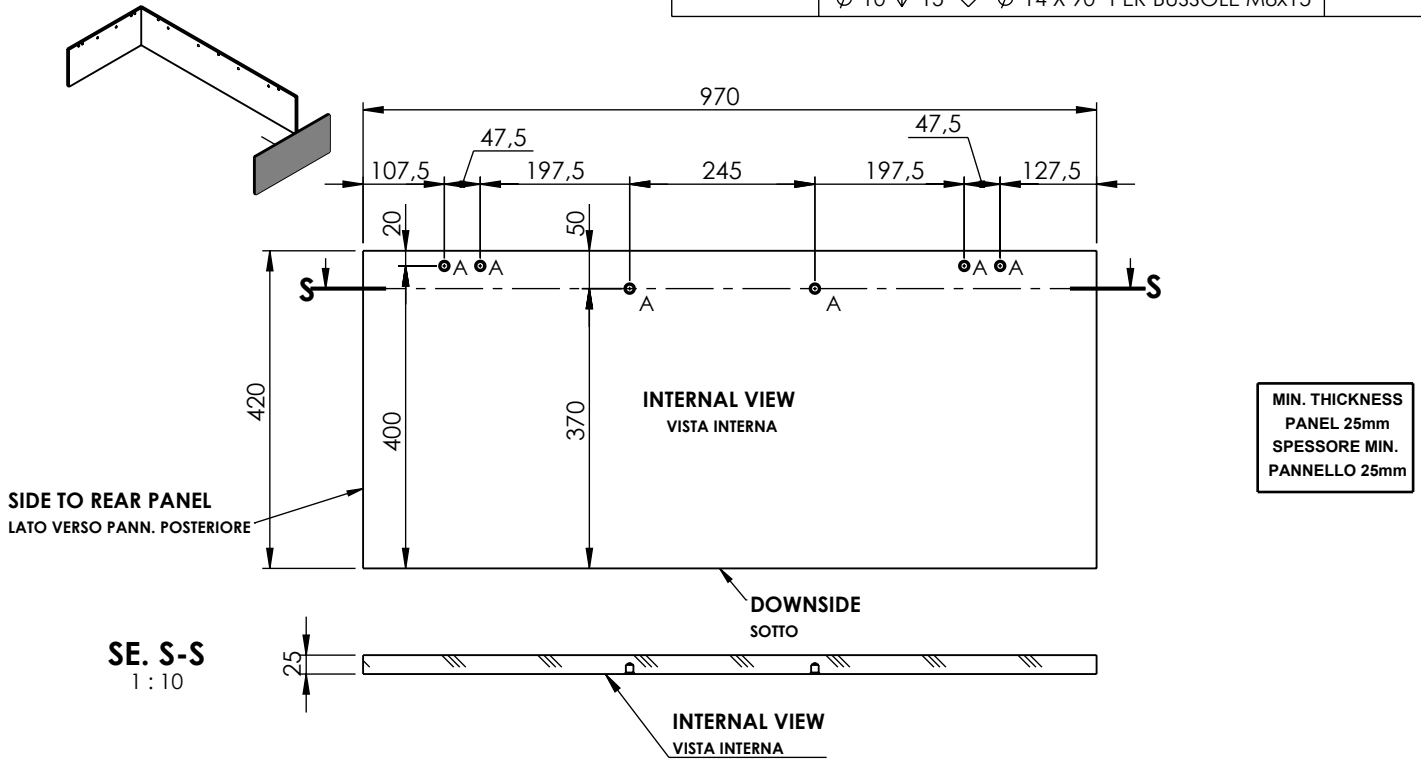

LEFT HEAD / FOOTBOARD PANEL

TESTIERA / PEDIERA SINISTRA

RIF.	DESCR.	QT
A	$\varnothing 10 \nabla 15 \sphericalangle \varnothing 14 \times 90^\circ$ FOR BUSHINGS M8x15 $\varnothing 10 \nabla 15 \sphericalangle \varnothing 14 \times 90^\circ$ PER BUSSOLE M8x15	6

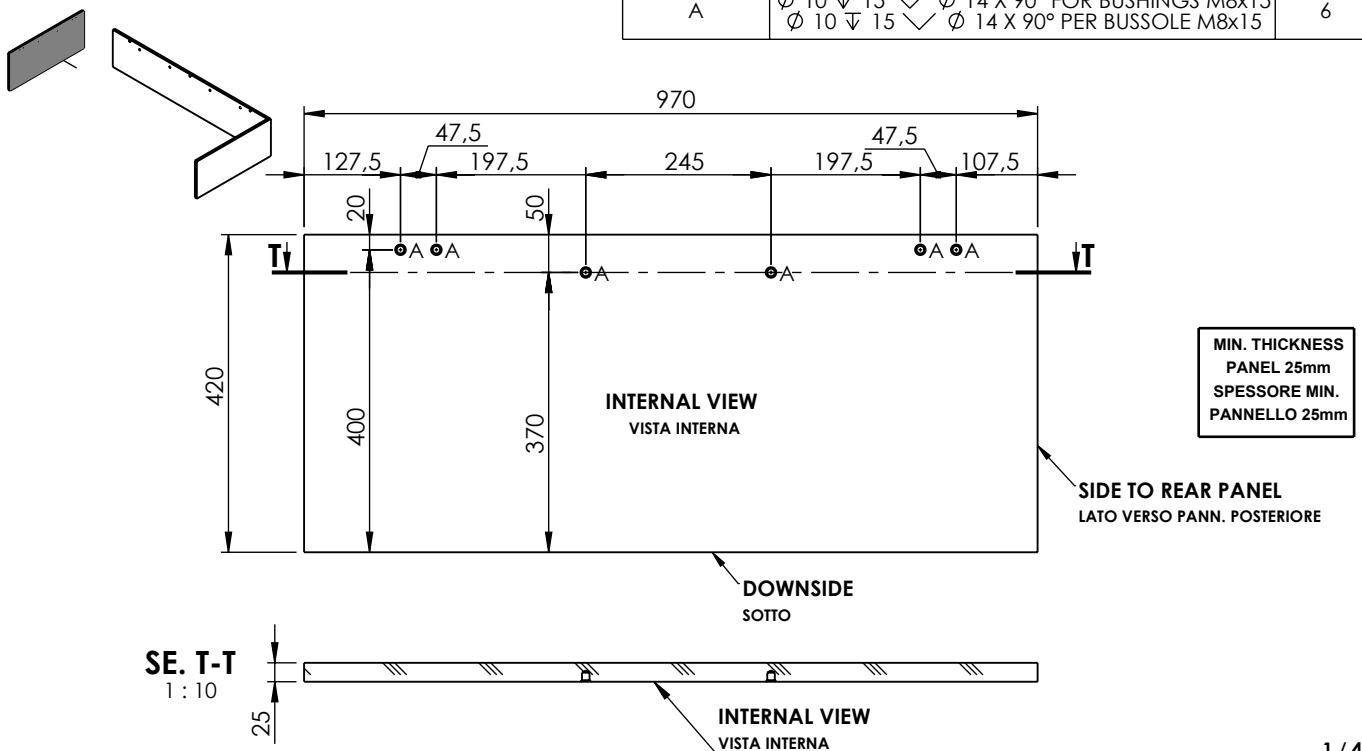

BACK PANEL

FIANCO POSTERIORE

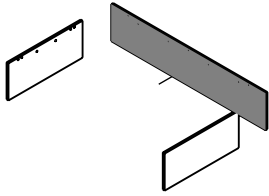

RIF.	DESCR.	QT
A	$\varnothing 10 \nabla 15 \checkmark \varnothing 14 \times 90^\circ$ FOR BUSHINGS M8x15 $\varnothing 10 \nabla 15 \checkmark \varnothing 14 \times 90^\circ$ PER BUSSOLE M8x15	7

MIN. THICKNESS
PANEL 25mm
SPESSORE MIN.
PANNELLO 25mm

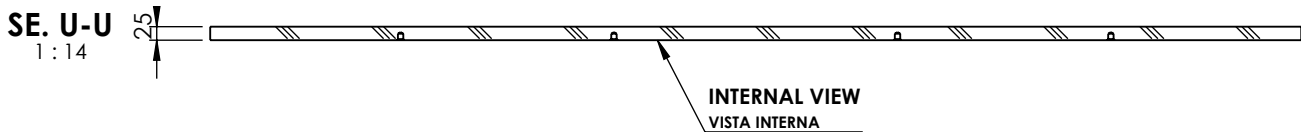
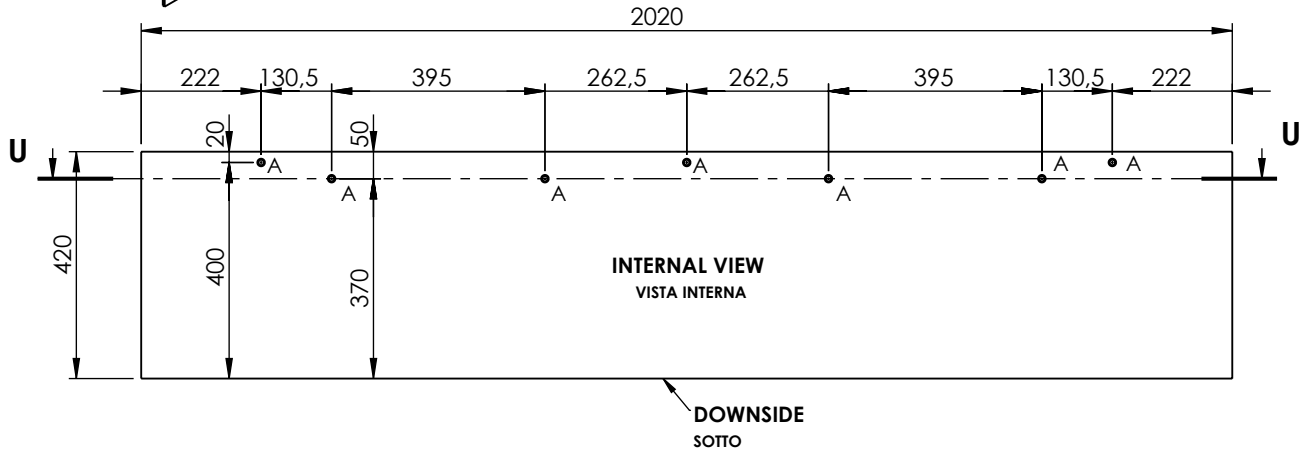

FIXED STRUCTURE FURNITURE

MOBILE STRUTTURA FISSA

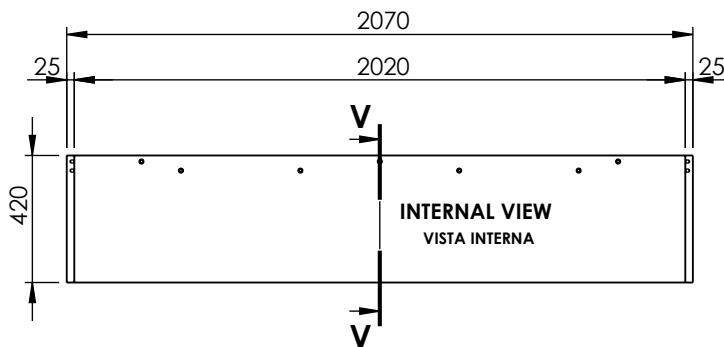

SE. V-V
1:25

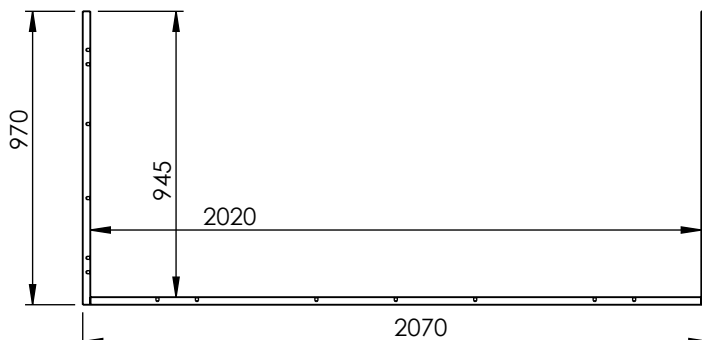
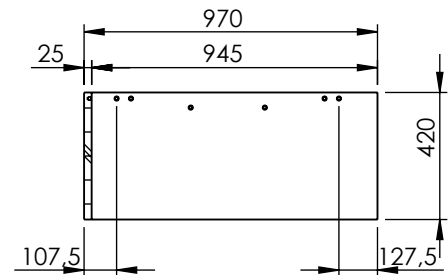

WARNING: DIMENSIONS VALID ONLY FOR WOODEN BOX CONTAINERS. FOR PADDED VERSIONS CHECK FOR POSSIBLE DIFFERENCES

ATTENZIONE: DIMENSIONI VALIDE SOLO PER CONTENITORI BOX IN LEGNO. PER LE VERSIONI IMBOTTITE VERIFICARE EVENTUALI DIFFERENZE

RIGHT HEAD / FOOTBOARD PANEL

TESTIERA / PEDIERA DESTRA

RIF.	DESCR.	QT
A	$\varnothing 20 \nabla 10$ BLIND HOLE $\varnothing 20 \nabla 10$ FORO CIECO	4
B	$\varnothing 10 \nabla 15 \sphericalangle \varnothing 14 \times 90^\circ$ FOR BUSHINGS M8x15 $\varnothing 10 \nabla 15 \sphericalangle \varnothing 14 \times 90^\circ$ PER BUSSOLE M8x15	8
C	$20 \times 40 \nabla 10$ BLIND EYELET $20 \times 40 \nabla 10$ ASOLE CIECHE	2

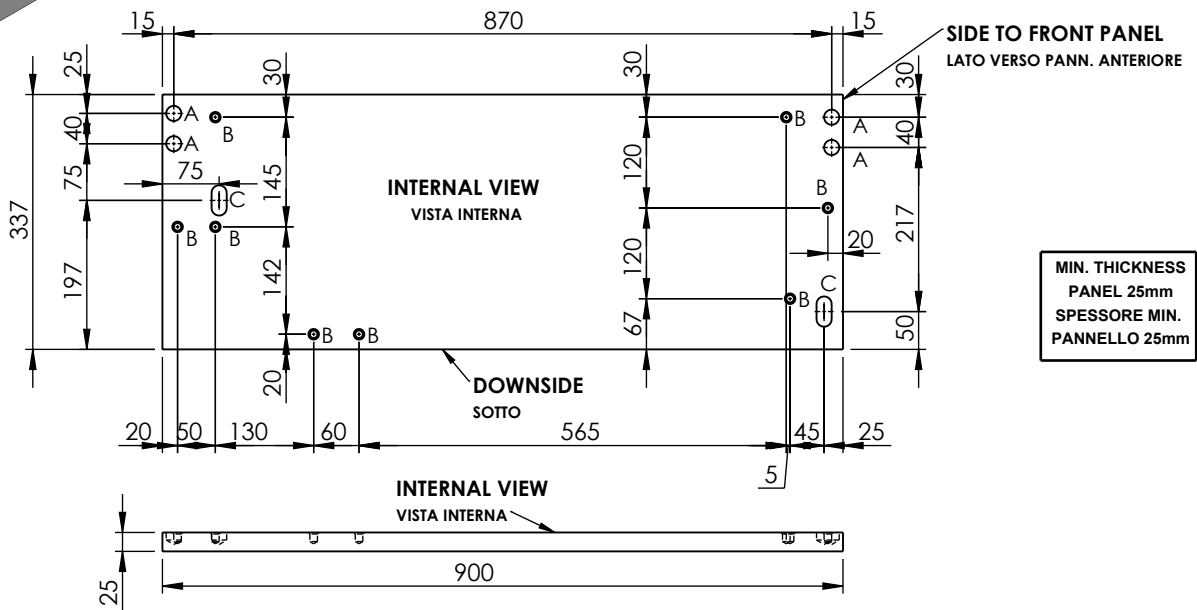
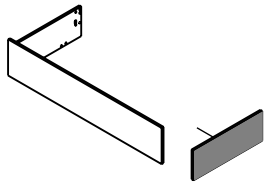

LEFT HEAD / FOOTBOARD PANEL

TESTIERA / PEDIERA SINISTRA

RIF.	DESCR.	QT
A	$\varnothing 20 \nabla 10$ BLIND HOLE $\varnothing 20 \nabla 10$ FORO CIECO	4
B	$\varnothing 10 \nabla 15 \sphericalangle \varnothing 14 \times 90^\circ$ FOR BUSHINGS M8x15 $\varnothing 10 \nabla 15 \sphericalangle \varnothing 14 \times 90^\circ$ PER BUSSOLE M8x15	8
C	$20 \times 40 \nabla 10$ BLIND EYELET $20 \times 40 \nabla 10$ ASOLE CIECHE	2

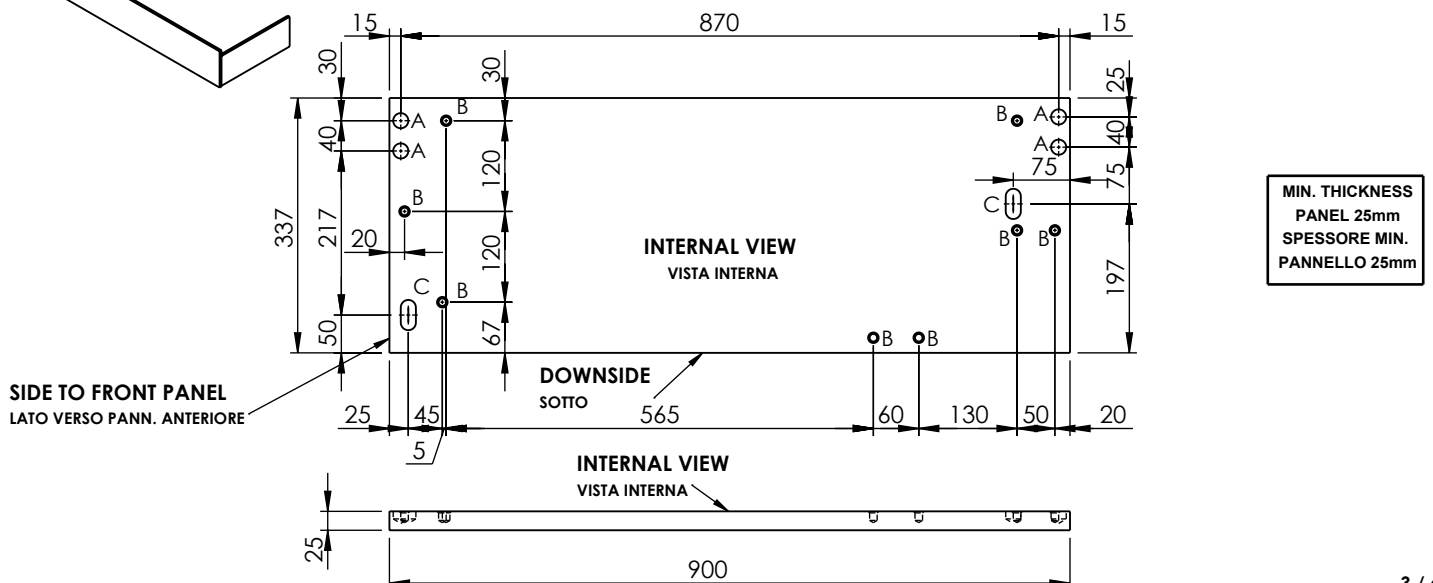
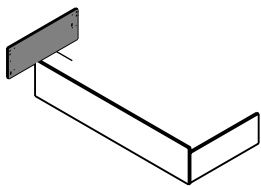

FRONT PANEL

PANNELLO FRONTALE

RIF	DESCR.	QT
A	$\phi 10 \nabla 15 \sphericalangle \phi 14 \times 90^\circ$ FOR BUSHINGS M8x15 $\phi 10 \nabla 15 \sphericalangle \phi 14 \times 90^\circ$ PER BUSSOLE M8x15	6

MIN. THICKNESS
PANEL 25mm
SPESSORE MIN.
PANNELLO 25mm

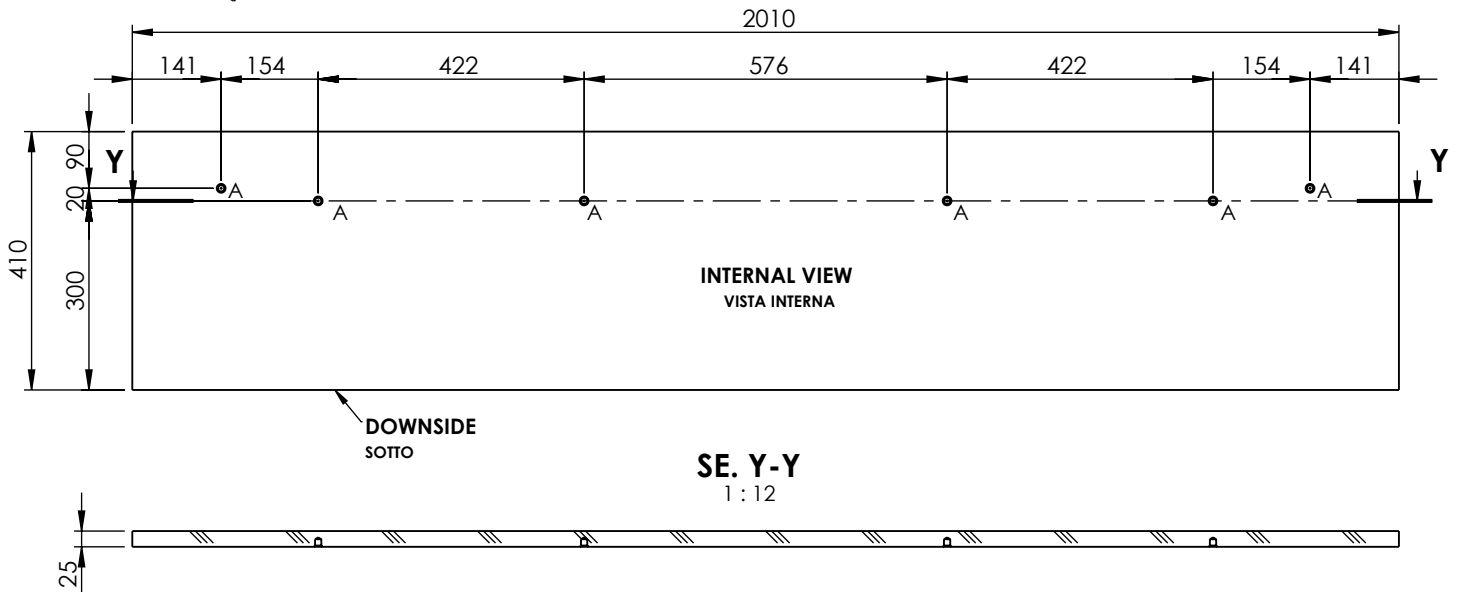

PULL-OUT BED STRUCTURE FORNITURE

MOBILE STRUTTURA LETTO ESTRAIBILE

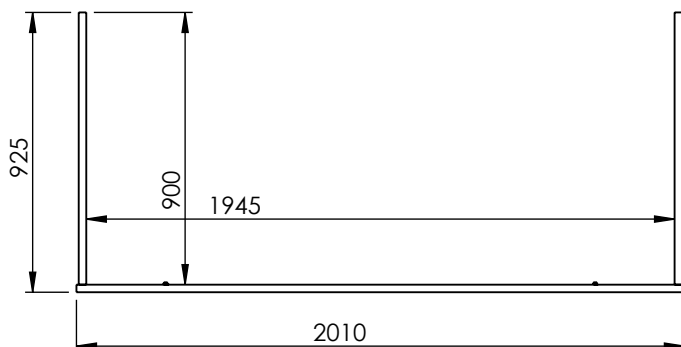
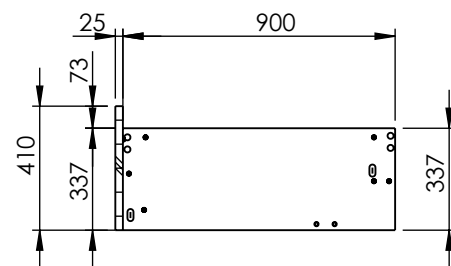
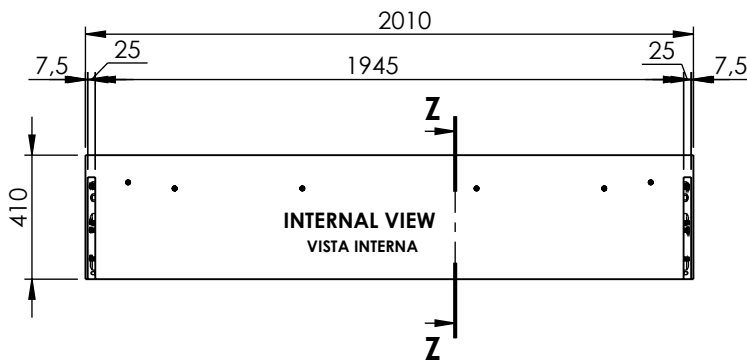

WARNING: DIMENSIONS VALID ONLY FOR WOODEN BOX CONTAINERS. FOR PADDED VERSIONS CHECK FOR POSSIBLE DIFFERENCES

ATTENZIONE: DIMENSIONI VALIDE SOLO PER CONTENITORI BOX IN LEGNO. PER LE VERSIONI IMBOTTITE VERIFICARE EVENTUALI DIFFERENZE