

Utopni ročajji

Stavbno okovje in tesnila
/ Utopni ročajji



Utopni ročaj

Art. 123/1

KNKG100CL (Krom)

KNKG100CS (Satin)

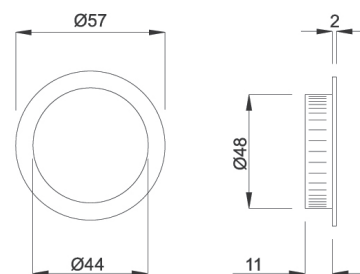

Utopni ročaj

Art. 123/5

KNKG500CL (Krom)

KNKG500CS (Satin)

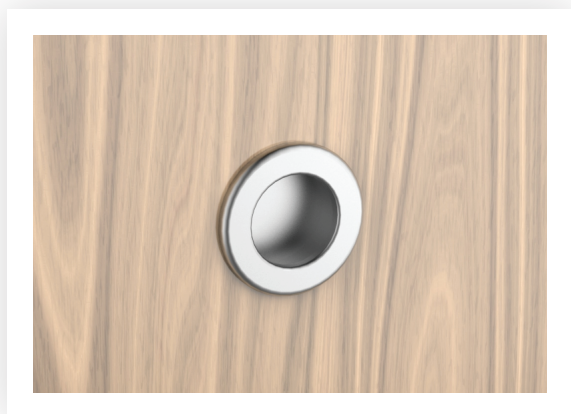
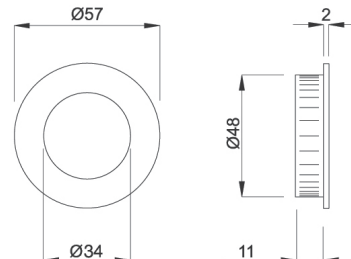

Utopni ročaj 2097

Art. L209701 (Zlata)

Art. L209703 (Krom)

Art. L209708 (MAT krom)

Art. L209711 (Črna)



Utopni ročaji

Stavbno okovje in tesnila
/ Utopni ročaji



Utopni ročaj OVAL

Art. 5317281 (Zlata)

Art. 5317283 (Krom)

Art. 5317285 (INOX brušen)

Vgradna dimenzija: 102 x 25 mm

Utorna globina: 11 mm

Š: 151 / V: 40 / G: 2,5 mm

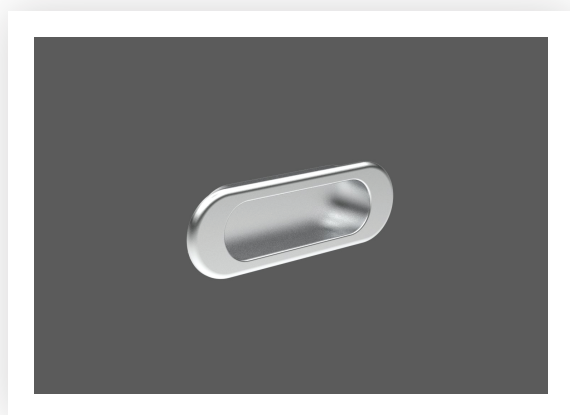
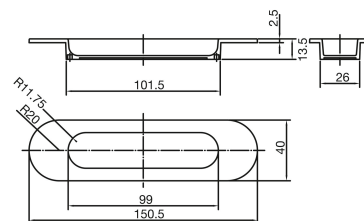

Utopni ročaj 2099

Art. L209901 (Zlata)

Art. L209903 (Krom)

Art. L209901 (MAT krom)

Art. L209911 (Črna)

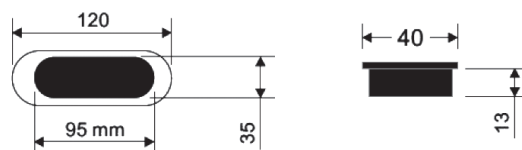

Naprstnik

Art. KT1220CS

SE122 (Satin)

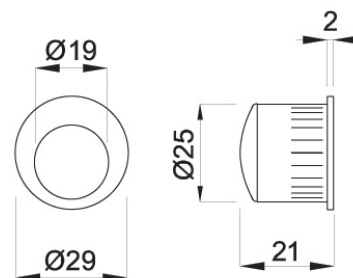

Utopni ročaji

Stavbno okovje in tesnila
/ Utopni ročaji



Utopni ročaj za drsna vrata - stranski

Art. TR00128CRS

SE128 (Satin)

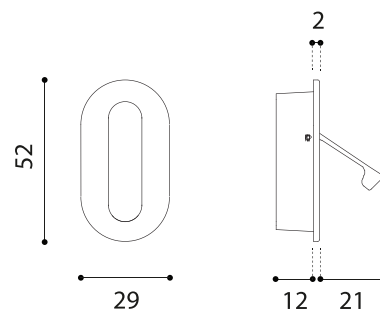

Utopni ročaj 403.07

Art. 403.07

Barva: ALU

Dolžine: 147, 179, 211, 243, 275 mm

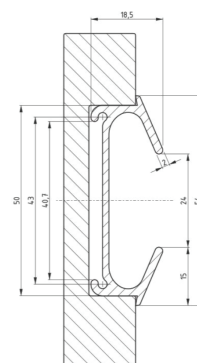

Utopni ročaj U6.137

Art. U6.137

Barva: Črna, MAT krom, MAT nikelj, krom, bela

Dolžina: 142 mm

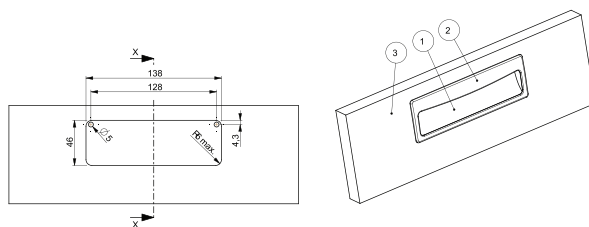

Utopni ročaji

Stavbno okovje in tesnila
/ Utopni ročaji



Utopni ročaj U6.56

Art. U6.56

Barva: Črna, MAT krom, MAT nikelj, krom, bela
Dolžina: 61 mm

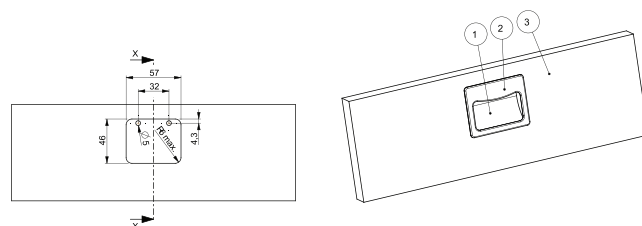

Utopni ročaj U9.175

Art. U9.175

Barva: Črna, MAT krom, SAT nikelj, bela, vintage, krom
Dolžina: 175 mm

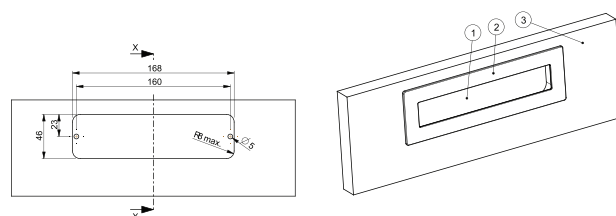

Utopni ročaj U9.41

Art U9.41

Barva: Črna, MAT krom, SAT nikelj, bela,
vintage, krom
Dolžina: 41 mm

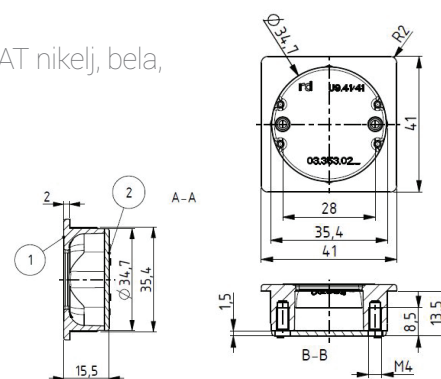

Utopni ročaji



Utopni ročaj U12AC

Art.U12AC

Barva: SAT nikelj, MAT krom (Satiniran)

Dolžina: 108, 172 mm

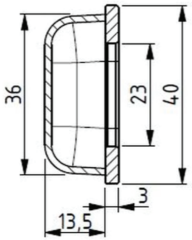

Zapiski

Blank lined area for notes, consisting of approximately 20 horizontal lines.

