

# Seriya 2300

VILLES

Pohištenveni drsni sistemi  
/ Drsni sistemi za omare



## Pomembno

Okovje za pohištenvena drsna vrata pred omaro  
Eno okovje za debelino vrat od 18 do 28 mm  
Kolesa nastavljiva po odklonu, višini in globini  
Nosilnosti do 65 kg  
Enostavna in hitra montaža (Clip sistem)  
ALU vodila dolžine 6m (režemo na mero)

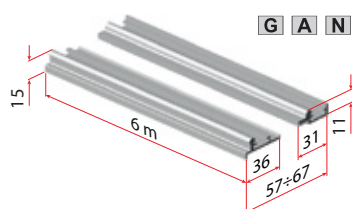

Art. 2301-2

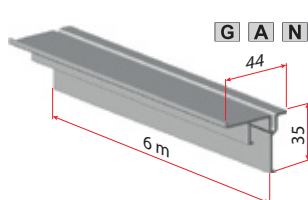

Art. 2002

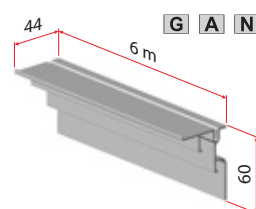

art. 2062

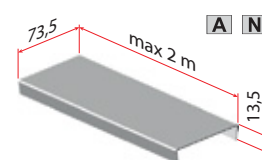

Art. 2009

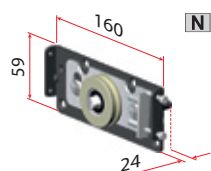

Art. 2003/SX/N

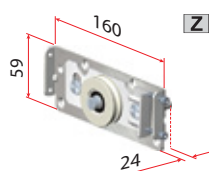

Art. 2003/SX/Z

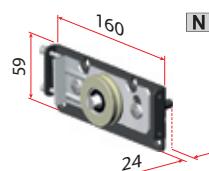

Art. 2003/DX/N

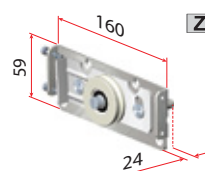

Art. 2003/DX/Z

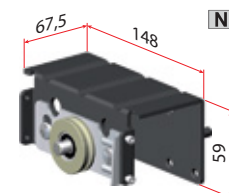

Art. 2005/30/SX/N

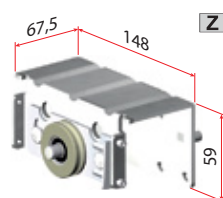

Art. 2005/30/SX/Z

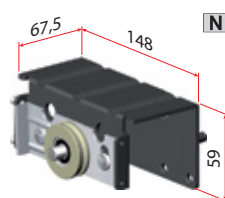

Art. 2005/30/DX/N

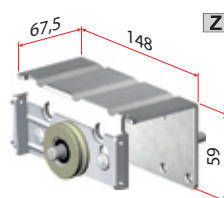

Art. 2005/30/DX/Z

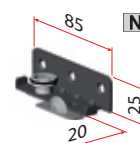

Art. 2004/SX/N

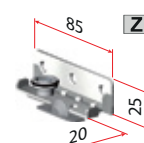

Art. 2004/SX/Z

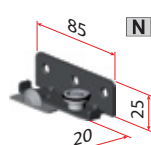

Art. 2004/DX/N

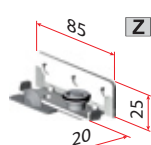

Art. 2004/DX/Z

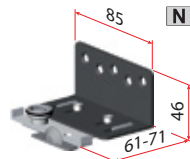

Art. 2306/SX/N

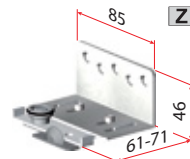

Art. 2306/SX/Z

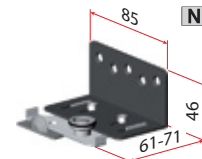

Art. 2306/DX/N

# Seriya 2300

VILLES

Pohištenveni drsni sistemi  
/ Drsni sistemi za omare

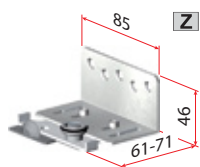

Art. 2306/DX/Z

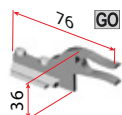

Art. 2007

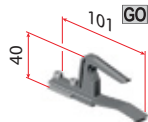

Art. 4407

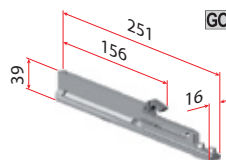

Art. 5357

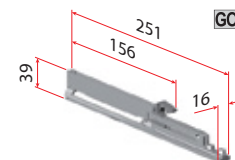

Art. 5357/S

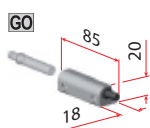

Art. 4448

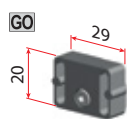

Art. 2008



Art. 2090

## Eno okovje za debelino vrat od 18 do 28 mm

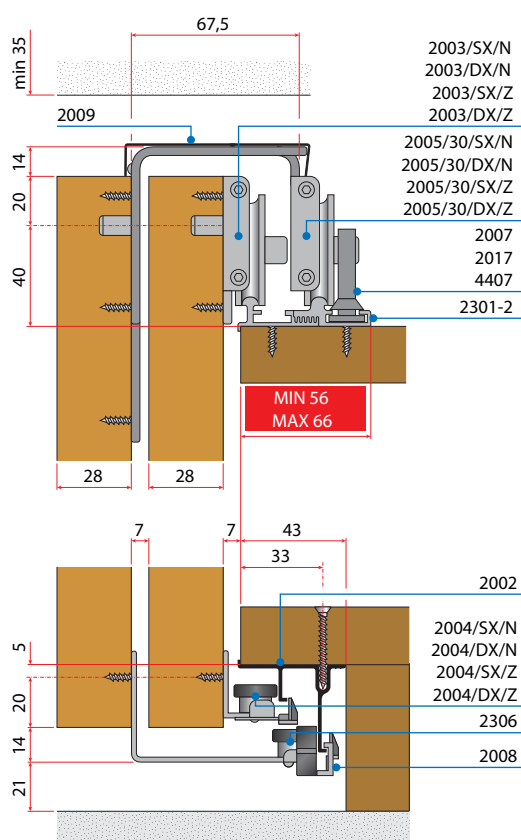

### Set

2003-4/N  
2305-6/N  
2003-4/Z  
2305-6/Z

### Alternativa za art. 2002

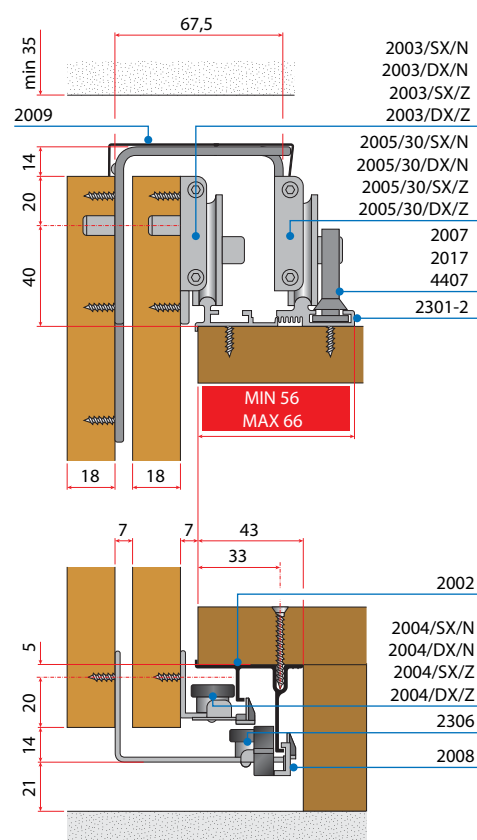
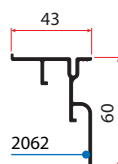

# Seriya 2300

VILLES

Pohištvni drsni sistemi  
/ Drsni sistemi za omare

## Priprava izvrtin za notranja in zunanja vrata v primeru, da je stranica omare 25 mm

\* V kolikor stranica ni 25 mm preračunajte začetne mere

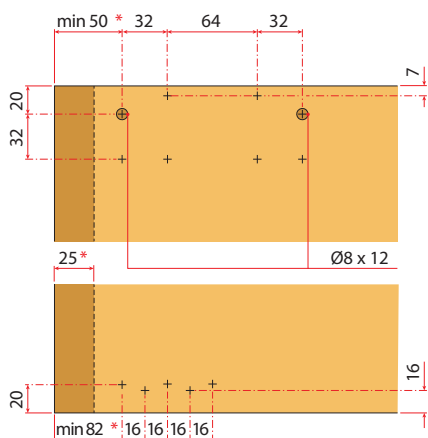

### Zgornja PVC zavora

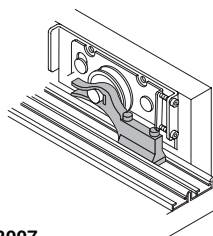

Art. 2007

Zgoraj PVC zavora.  
Lahko uporabite alternativo art. 4407

### Spodnja PVC zavora

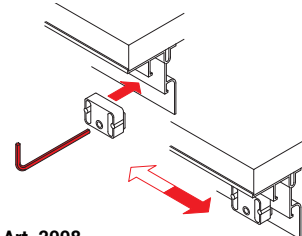

Art. 2008

Spodnja zavora je / odbojnik je fiksiran z vijakom na vodilo

## Regulacijsko zgornje vodilo art. 2301-2

Regulacijsko zgornje vodilo **2301-2** dovoljuje debelino vrat od 18 do 28 mm.

Za različne debeline vrat prestavite vodilo kot je prikazano na skici desno.

Nato pritrdite vodilo na omaro.

### Vrata 28 mm

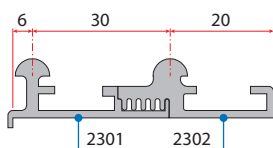

### Vrata 26 mm

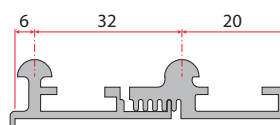

### Vrata 24 mm

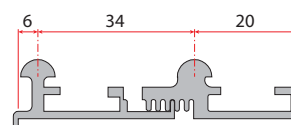

### Vrata 22 mm

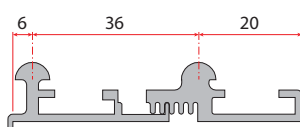

### Vrata 20 mm

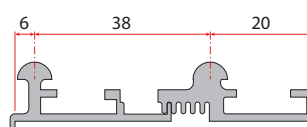

### Vrata 18 mm

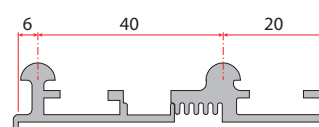

## Regulacijsko spodnje kolo za zunanja vrata

Regulacijsko kolo art. **2306** dovoljuje debelino vrat od 18 do 28 mm.

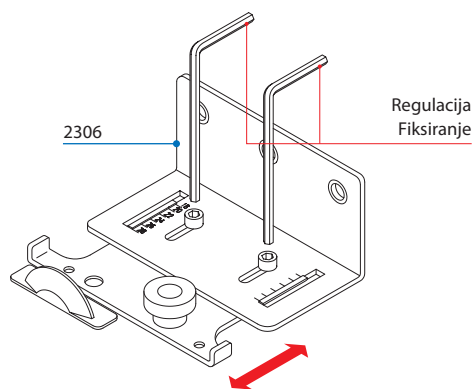

# Seriya 2300

VILLES

Pohištenveni drsni sistemi  
/ Drsni sistemi za omare

## Navodila za montažo

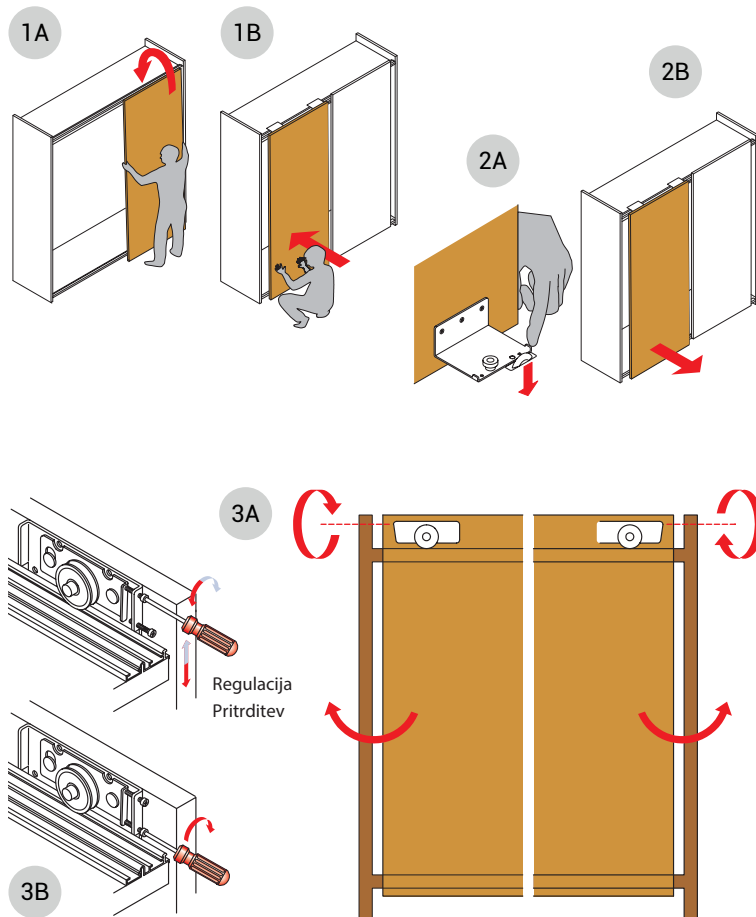

### Navodila za notranja in zunanja vrata

**1A** Najprej nastavite zgornja kolesa na vodilo zgoraj.

**1B** Pritisnite vrata spodaj tako, da se kolo zaskoči na spodnje vodilo. Odstranitev notranjih in zunanjih vrat z omare.

### Odstranitev notranjih in zunanjih vrat z omare

**2A** Za odstranitev vrat pritisnite zaskočnik na nosilcu kolesa in izmaknite vrata z vodila.

**2B** Privzdignite vrata in jih odstranite z omare.

### Regulacija vrat

**3A** Višinska regulacija vrat se izvede z zgornjim vijakom na kolesu.

**3B** Fiksiranje se izvede po regulaciji vrat s spodnjim vijakom na kolesu.

## Različne opcije

### Montaža Soft-Close zavore art. 4478

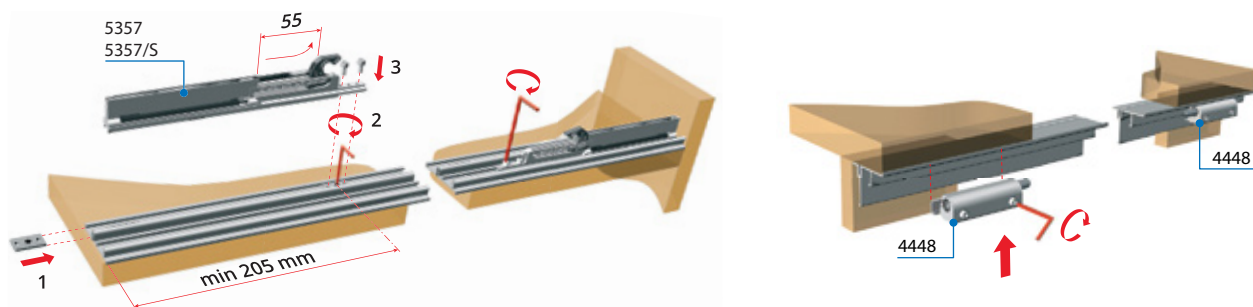

# Seriya 2300

VILLES

Pohištenveni drsni sistemi  
/ Drsni sistemi za omare

## Priprava vrat s Soft-Stop zavoro (art. 4478)

\* V kolikor stranica ni 25 mm preračunajte začetne mere (min. 120 zg, min. 122 sp).

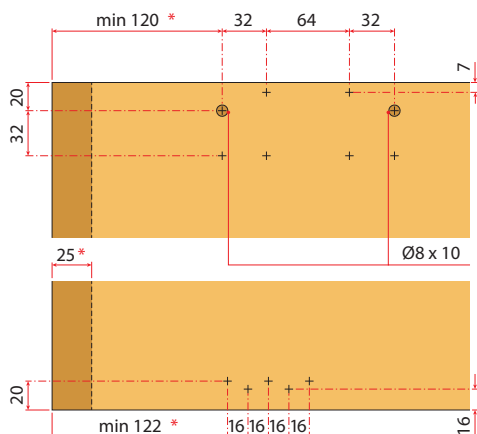

### Različne zavore zgoraj

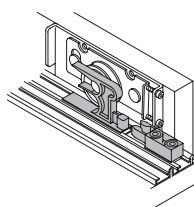

**Art. 2017**  
Skrita zavora zgoraj  
sestavljena iz dveh  
delov

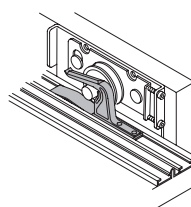

**Art. 4407**  
Zgornja PVC zavora

### Čep proti izpadu kolesa

#### Art. 2010

Vstavite ga pred  
vstavitvijo vrat na omaro

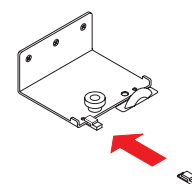

## Seti in profili



**2003-4/N**

Art. 2003/SX/N x1 | 2003/DX/N x1 | 2004/SX/N x1 | 2004/DX/N x1  
2007 x2 | 2008 x2 | 2090 x1

65 Kg 600 ÷ 1800 1 SOFT AUTO

**2003-4/Z**

Art. 2003/SX/Z x1 | 2003/DX/Z x1 | 2004/SX/Z x1 | 2004/DX/Z x1  
2007 x2 | 2008 x2 | 2090 x1

65 Kg 600 ÷ 1800 1 SOFT AUTO

**2305-6/N**

Art. 2005/30/SX/N x1 | 2005/30/DX/N x1 | 2306/SX/N x1 | 2306/DX/N x1  
2007 x2 | 2008 x2 | 2090 x1

65 Kg 600 ÷ 1800 1 SOFT AUTO

**2305-6/Z**

Art. 2005/30/SX/Z x1 | 2005/30/DX/Z x1 | 2306/SX/Z x1 | 2306/DX/Z x1  
2007 x2 | 2008 x2 | 2090 x1

65 Kg 600 ÷ 1800 1 SOFT AUTO

**4478/S**

Art. 5357/S x2 | 4448 x2

65 Kg 800 ÷ 2000 1 SOFT AUTO