

1 JUNIOR-6 SLIDING DOORS SYSTEMS

JUNIOR-6-60 INDAmatic

Take better advantage of the inner space of the wardrobe thanks to the reduced width by 60 mm of the upper track. Can be used with the gradual soft-closing INDAmatic system.

Dual upper track

4.2m profiles	INDAmatic
Silver-anodised	716.542.105
Matt silver-anodised	716.542.514
Brass-anodised	716.542.783
Black-anodised	716.542.890
Gold-anodised	716.542.772
Laquered white RAL 9010	716.542.805

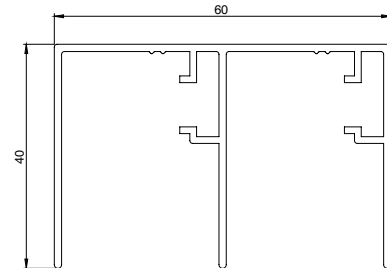

Lower track

4.2m profiles	Single *	Dual
Silver-anodised	714.342.101	716.242.100
Matt silver-anodised	714.342.510	716.242.516
Brass-anodised	714.342.786	716.242.785
Black-anodised	714.342.893	716.242.892
Gold-anodised	714.342.775	716.242.774
Laquered white RAL 9010	714.342.801	716.242.800

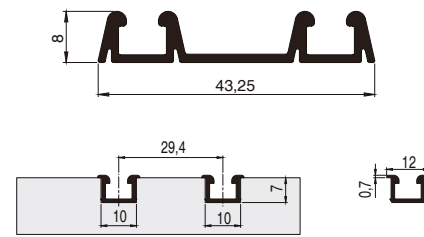

Pulling profile for 16mm

	5.2m profiles	
Matt silver-anodised	716.752.514	10
Silver-anodised	716.752.105	
Laquered white	716.752.805	

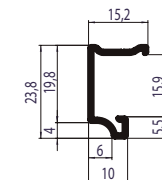

Bag of components for 2 doors with INDAmatic

With bearing	704.462.102
--------------	-------------

Each reference consists of 4 upper rollers (2 lefts and 2 rights), 4 lower rollers and 4 INDAmatic devices.

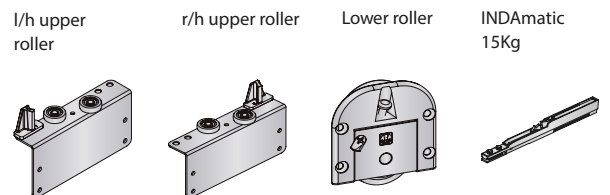

Bag of components for 3 doors with INDAmatic

With bearing	704.463.104
--------------	-------------

Each reference consists of 6 upper rollers (3 left and 3 right), 6 lower rollers, 1 door positioner and 4 INDAmatic device.

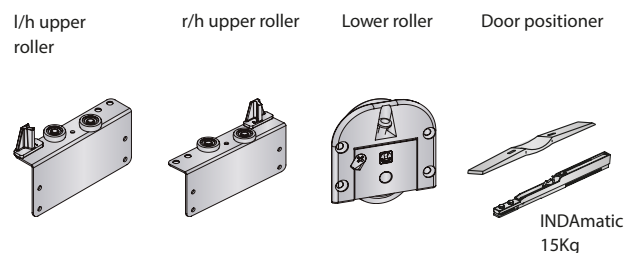

■ JUNIOR-6-60 INDAmatic TECHNICAL DATA

Upper part

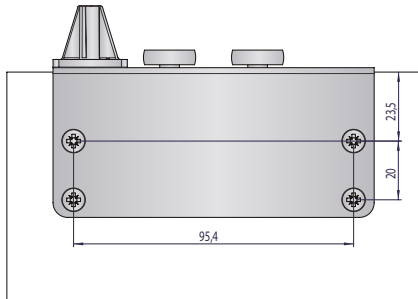

Lower part

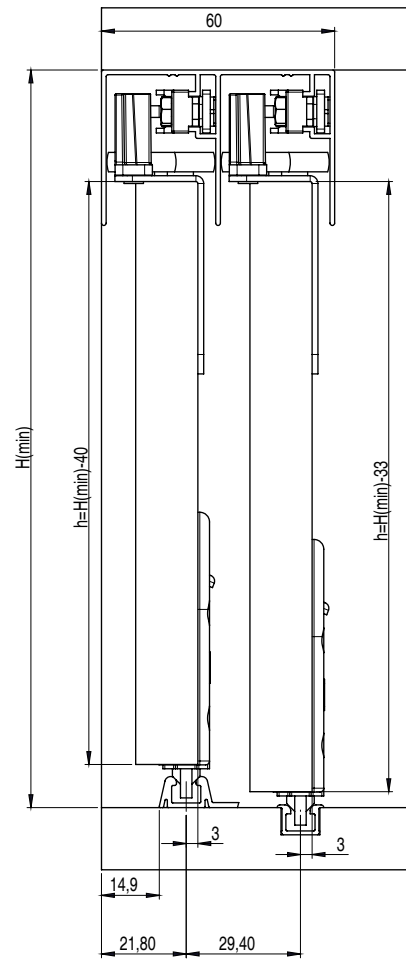
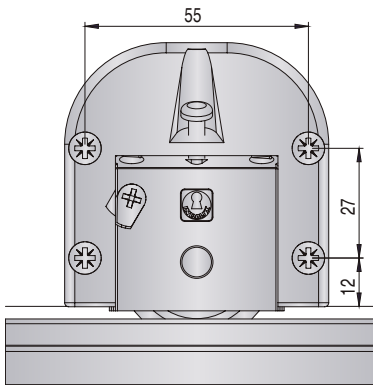

Housing for inlayed fittings

